

TENT ROLLBAR

Go to Index



UNIVERSAL

**AQM
S75**



MOUNTING INSTRUCTION COMPATIBLE FOR ALL PRODUCTS

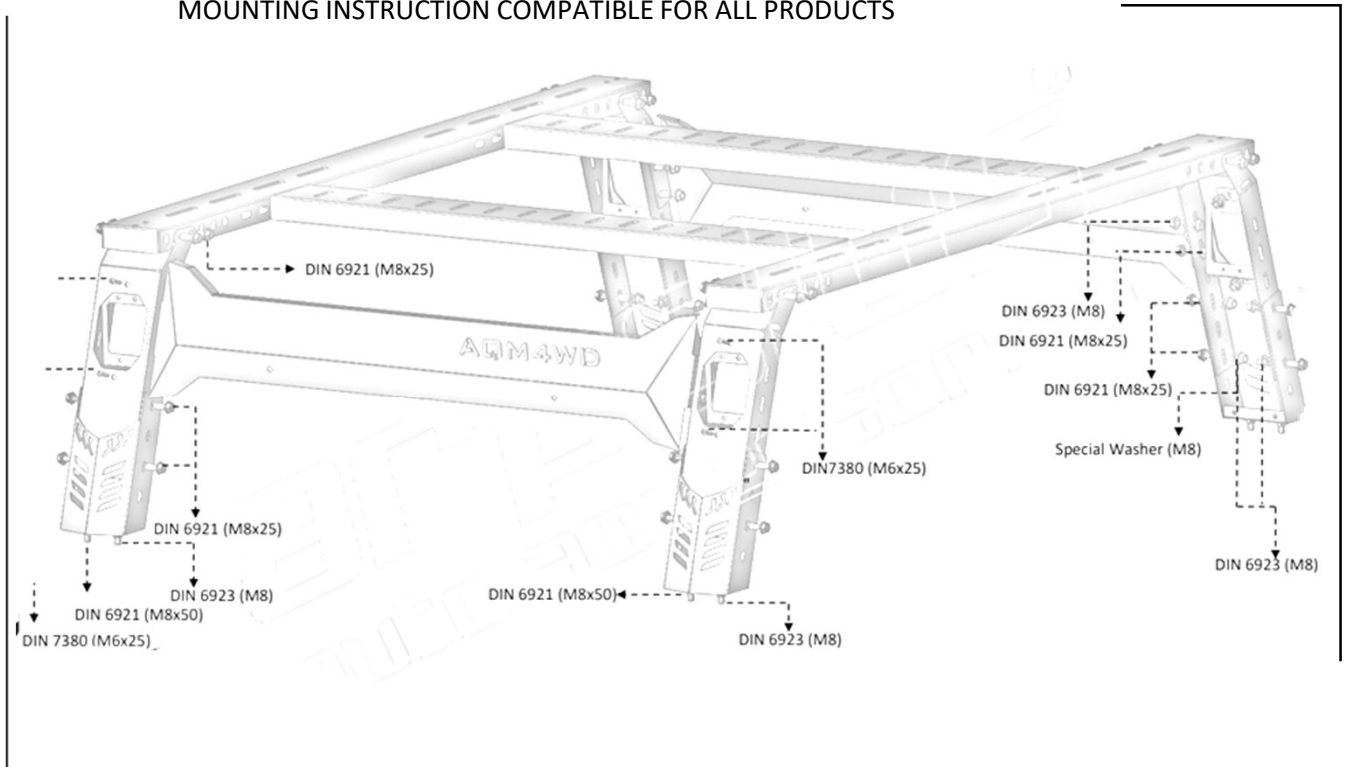

**VERIFY YOU HAVE ALL THE COMPONENTS BEFORE STARTING THE INSTALLATION.
REFER TO THE ENGINEERING DRAWINGS AT THE END OF THIS DOCUMENT FOR A COMPLETE
PARTS LIST**

2201TR - 01

Go to Index



1. Mount Installation

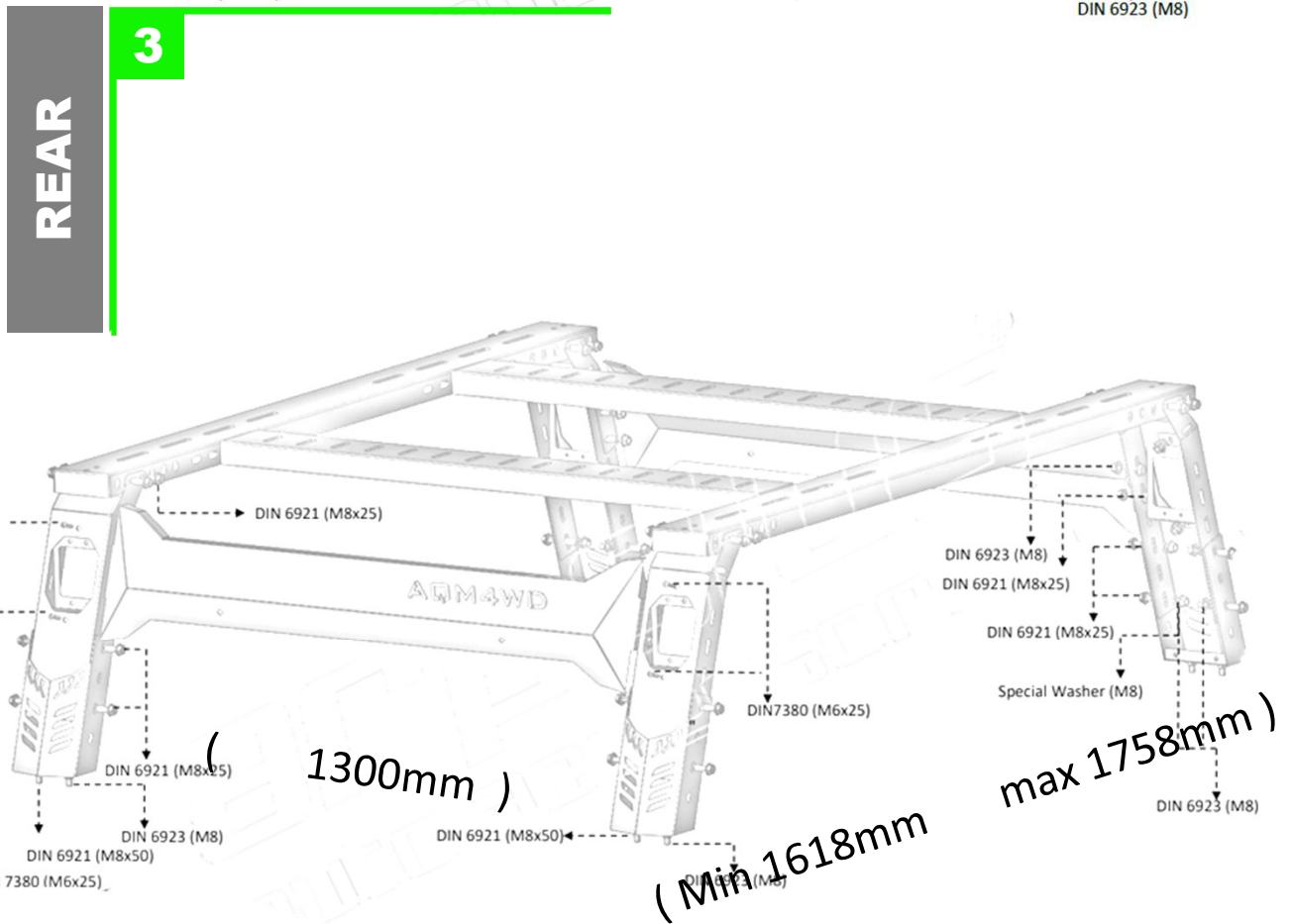
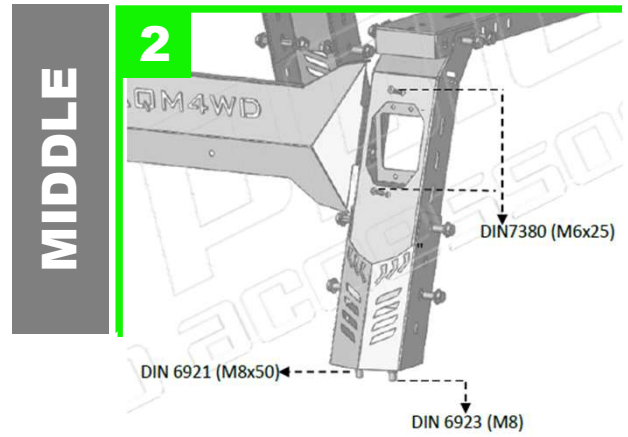
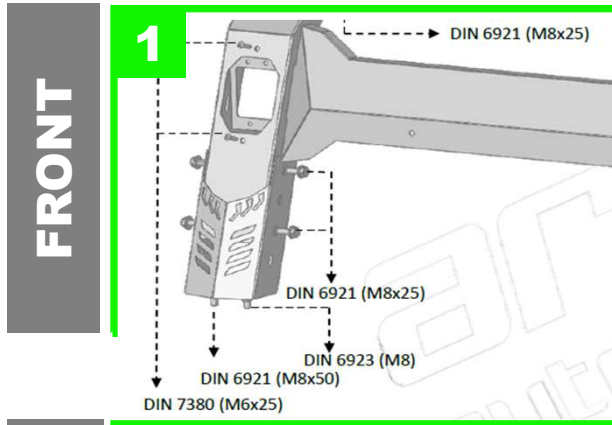

Go to Index



1. Mount Installation

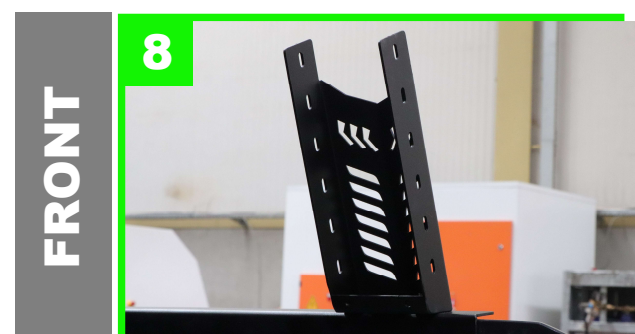
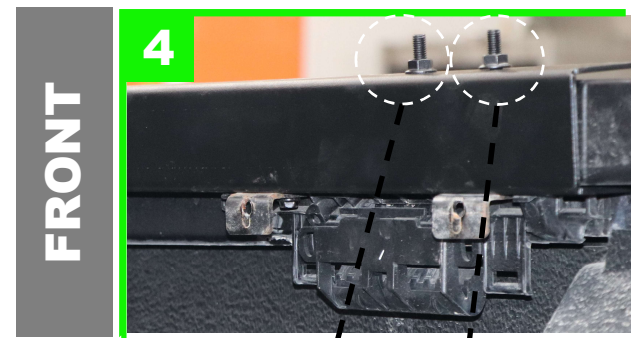
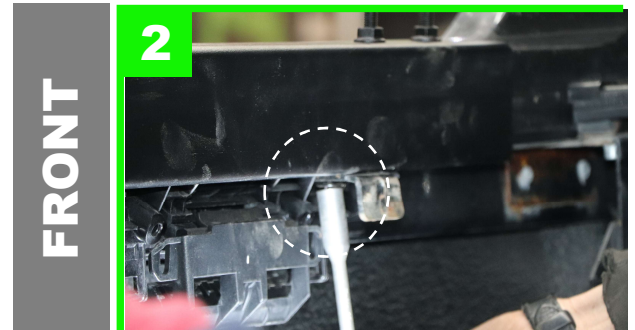

2201TR - 01

Go to Index



1. Mount Installation



2201TR - 01

Go to Index



1. Mount Installation



2201TR - 01



1. Mount Installation

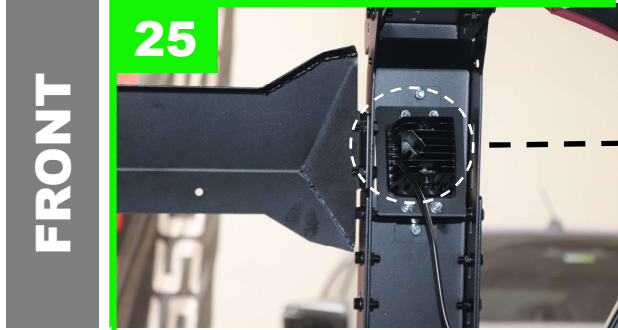







Ürün toplam 18 parçadan oluşmaktadır. Aracın kasası delinerek, civat a ve somun yardımıyla montaj yapılmaktadır. Ledler için ekstra bağlantı aparatı mevcuttur.

Go to Index



3. Bolt Kit

Designation	Part No	Name	Spec.	Q'ty
	1000	Bolts	DIN6921 (M8x20)CHROME QUALITY 8.8	48 pcs
	1000	Bolts	DIN6921 (M8x50) CHROME QUALITY 8.8	8 pcs
	1000	Bolts	DIN7380 (M6x16) CHROME QUALITY 8.8	8 pcs
	1002	Nuts	DIN6923 M8 CHROME QUALITY 6	56 pcs
	1002	Nuts	DIN 6923 M6 CHROME QUALITY 6	8 pcs
	1003	Special Washer	(M8)	72 pcs