

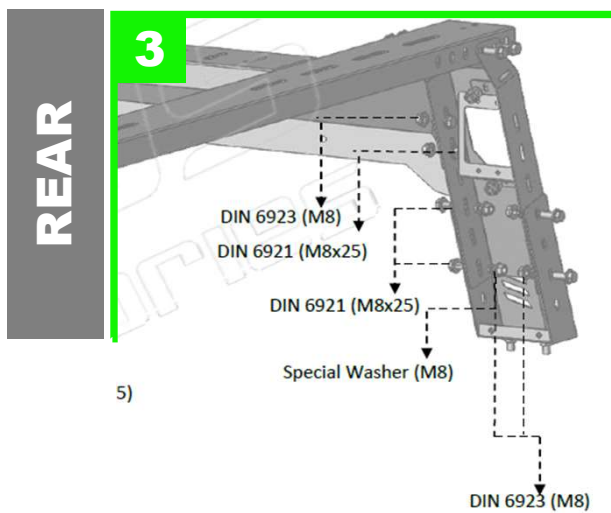

Go to Index

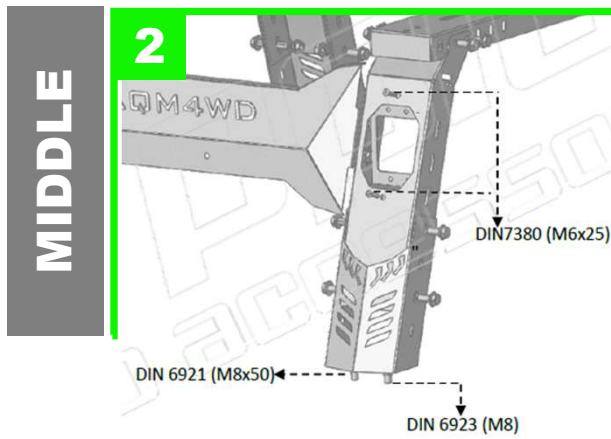

## 1. Mount Installation

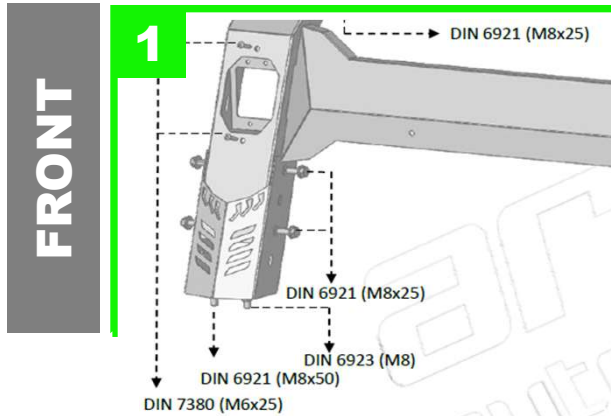

INSTALLATION DIAGRAMS

Go to Index



### 1. Mount Installation

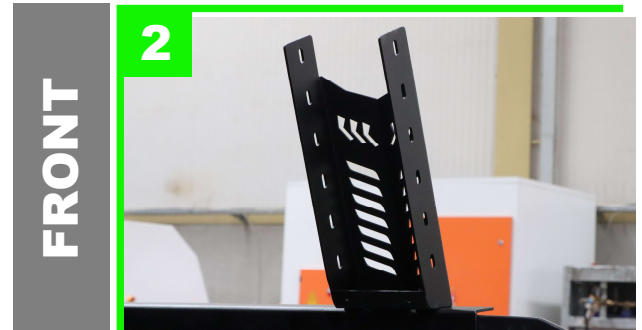

2201TR - 01

Go to Index



## 1. Mount Installation



2201TR - 01



## 1. Mount Installation

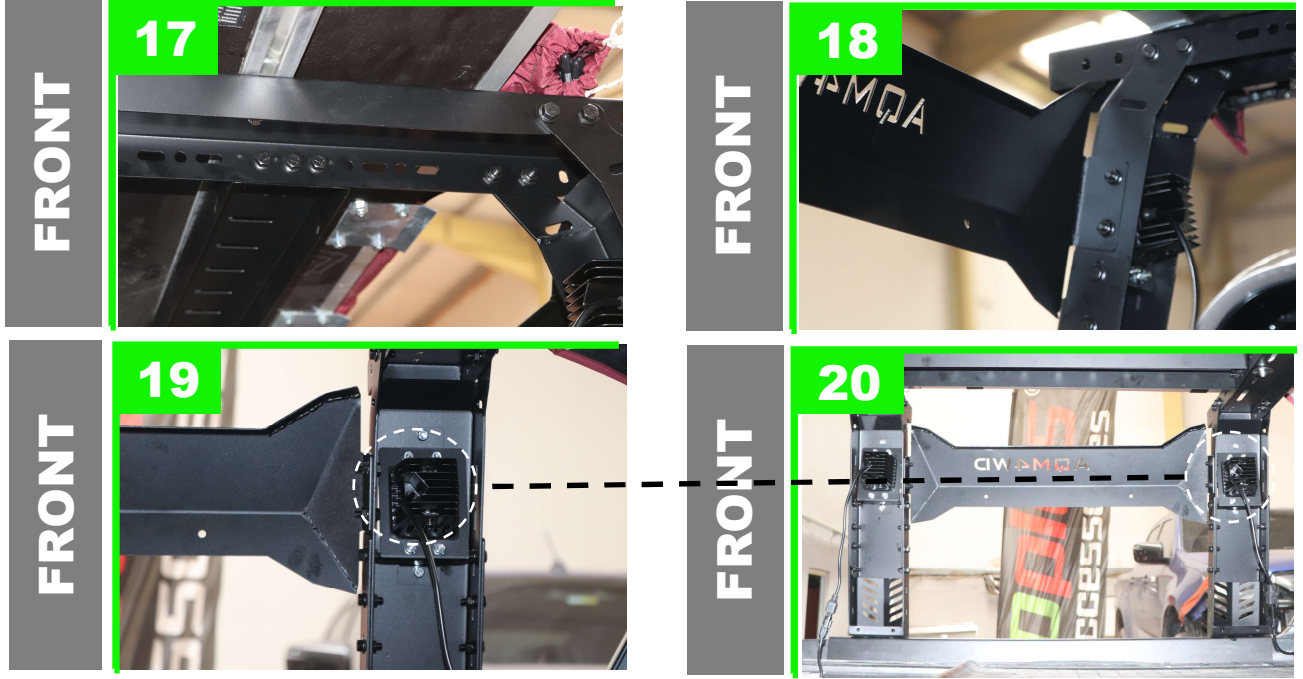

Ürün toplam 18 parçadan oluşmaktadır. Aracın kasası delinerek, civat a ve somun yardımıyla montaj yapılmaktadır. Ledler için ekstra bağlantı aparatı mevcuttur.

[Go to Index](#)



## 1. Mount Installation

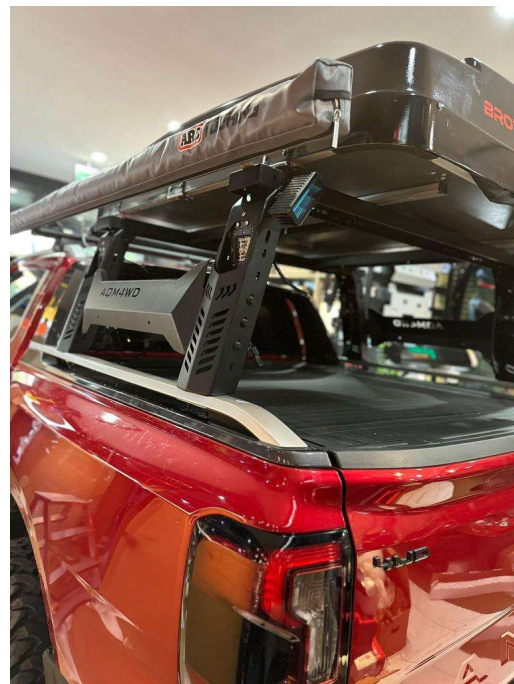







2201TR - 01

Go to Index



### 3. Bolt Kit

Designation	Part No	Name	Spec.	Q'ty
	1000	Bolts	DIN6921 (M8x20) CHROME QUALITY 8.8	48 pcs
	1000	Bolts	DIN6921 (M8x50) CHROME QUALITY 8.8	8 pcs
	1000	Bolts	DIN7380 (M6x25) CHROME QUALITY 8.8	8 pcs
	1002	Nuts	DIN6923 M8 CHROME QUALITY 6	56 pcs
	1002	Nuts	DIN934 M6 CHROME QUALITY 6	8 pcs
	1003	Washer	(M8)	104 pcs